

Stainless Steel Fittings

不锈钢快插接头

Features/ 特征

Stainless Steel Fittings suitable for all those applications where brass nickel-plated and acetal fittings are banned, the new AISI 316L fitting is conceived to withstand corrosive environments (substances), to channel aggressive fluids and to be used in the food and chemical industries. Stainless Steel fittings line is standard equipped with Viton seals that will assure endurance at the highest temperatures.

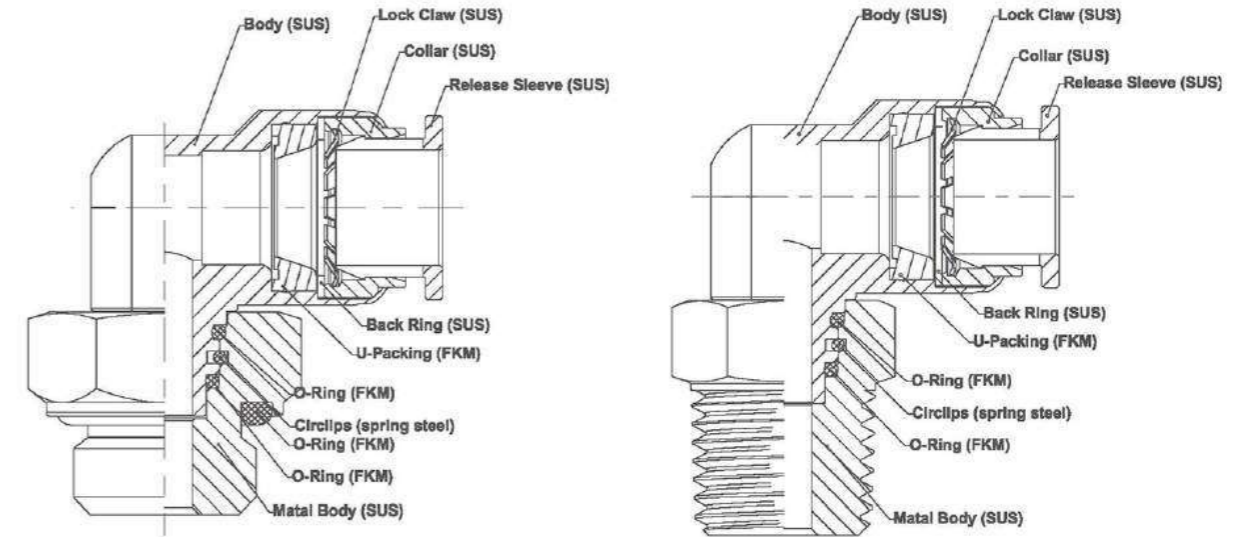

Specifications/ 技术规格

Applicable Fluid Type	Air, Water, Vacuum	
Working Pressure Range	-14 ~225 PSI	-0.99~ 15 Bar
Working Temperature Range	5 °F ~428 °F	-15°C ~220°C
Vacuum Rating	to 750mmHg	
Recommended Tubings	PA11, PA12, PA6, PE, PU, PTFE, FEP	
Applications	Pneumatics, Food Industry, Chemical, Medical and Pharmaceutical Industry	

Tube Outside Diameter You Can Choose As Follows:

您可以选择的气管外径尺寸如下:

	Metric Size/ 公制尺寸					Inch Size/ 英制尺寸				
Code No. 代码	4	6	8	10	12	5/32	1/4	5/16	3/8	1/2
Tube Outside Dia 气管外径	φ4	φ6	φ8	φ10	φ12	φ5/32	φ1/4	φ5/16	φ3/8	φ1/2

Thread Size For Your Choice As Follows:

您可以选择的螺纹尺寸如下:

Code No. 代码					
M5	M6	01	02	03	04
Thread Size 螺纹尺寸					
M5	M6	1/8	1/4	3/8	1/2

Stainless Steel Fittings

不锈钢快插接头

SSPC

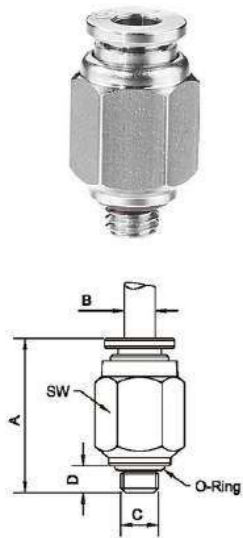

Item Code	A	B	C	D	SW
SSPC4-M5	20.1	4	M5	3.5	10
SSPC4-M6	21.1	4	M6	4.5	10
SSPC6-M5	20.7	6	M5	3.5	12
SSPC6-M6	21.7	6	M6	4.5	12
SSPC5/32-M5	20.1	5/32	M5	3.5	10
SSPC5/32-U10	20.1	5/32	U10-32	3.5	10
SSPC5/32-M6	21.1	5/32	M6	4.5	10
SSPC1/4-M5	20.7	1/4	M5	3.5	12
SSPC1/4-U10	20.7	1/4	U10-32	3.5	12
SSPC1/4-M6	21.7	1/4	M6	4.5	12
SSPC1/4-U01	24.7	1/4	UN1/8	6	14

SSPC



Item Code	A	B	C	D	SW
SSPC4-G01	22	4	G 1/8	5.5	14
SSPC4-G02	23.9	4	G 1/4	7	17
SSPC6-G01	20.8	6	G 1/8	5.5	14
SSPC6-G02	20.8	6	G 1/4	7	17
SSPC6-G03	20.8	6	G 3/8	8	19
SSPC6-G04	23.7	6	G 1/2	9	24
SSPC8-G01	27.8	8	G 1/8	5.5	14
SSPC8-G02	22.8	8	G 1/4	7	17
SSPC8-G03	23.8	8	G 3/8	8	19
SSPC8-G04	22.8	8	G 1/2	9	24
SSPC10-G01	27.8	10	G 1/8	5.5	17
SSPC10-G02	29.8	10	G 1/4	7	17
SSPC10-G03	30.8	10	G 3/8	8	19
SSPC10-G04	24.8	10	G 1/2	9	21
SSPC12-G02	31.6	12	G 1/4	7	19
SSPC12-G03	32.6	12	G 3/8	8	19
SSPC12-G04	27.6	12	G 1/2	9	24

SSPC



Item Code	A	B	C	D	SW
SSPC4-01	20.7	4	PT 1/8	8	10
SSPC4-02	24.1	4	PT 1/4	11	14
SSPC6-01	20.7	6	PT 1/8	8	12
SSPC6-02	24.7	6	PT 1/4	11	14
SSPC6-03	25.7	6	PT 3/8	12	19
SSPC6-04	30.7	6	PT 1/2	15	22
SSPC8-01	27	8	PT 1/8	8	14
SSPC8-02	25	8	PT 1/4	11	14
SSPC8-03	26	8	PT 3/8	12	19
SSPC8-04	31	8	PT 1/2	15	22
SSPC10-01	29.7	10	PT 1/8	8	17
SSPC10-02	32.2	10	PT 1/4	11	17
SSPC10-03	32.5	10	PT 3/8	12	19
SSPC10-04	36.5	10	PT 1/2	15	22
SSPC12-02	34.7	12	PT 1/4	11	19
SSPC12-03	34.7	12	PT 3/8	12	19
SSPC12-04	38.7	12	PT 1/2	15	22

SSPCF



Item Code	A	B	C	D	SW
SSPCF4-M5	23.6	4	M5	7	12
SSPCF4-M6	23.6	4	M6	7	12
SSPCF6-M5	23.7	6	M5	7	12
SSPCF6-M6	23.7	6	M6	7	12
SSPCF4-01	24.6	4	PT 1/8	8	14
SSPCF4-02	27.6	4	PT 1/4	11	17
SSPCF6-01	24.7	6	PT 1/8	8	14
SSPCF6-02	27.7	6	PT 1/4	11	17
SSPCF6-03	28.7	6	PT 3/8	12	19
SSPCF6-04	31.7	6	PT 1/2	15	24
SSPCF8-01	26.3	8	PT 1/8	8	14
SSPCF8-02	29.3	8	PT 1/4	11	17
SSPCF8-03	30.3	8	PT 3/8	12	19
SSPCF8-04	33.3	8	PT 1/2	15	24
SSPCF10-01	28.9	10	PT 1/8	8	17
SSPCF10-02	31.9	10	PT 1/4	11	17
SSPCF10-03	32.9	10	PT 3/8	12	19
SSPCF10-04	35.9	10	PT 1/2	15	24
SSPCF12-02	34.1	12	PT 1/4	11	21
SSPCF12-03	35.1	12	PT 3/8	12	21
SSPCF12-04	38.1	12	PT 1/2	15	24

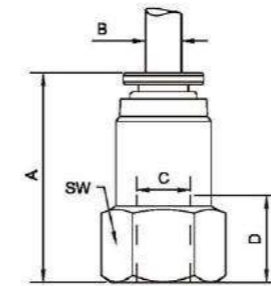

SSPCF5/32-M5	23.6	5/32	M5	7	12
SSPCF5/32-M6	23.6	5/32	M6	7	12
SSPCF1/4-M5	23.7	1/4	M5	7	12
SSPCF1/4-M6	23.7	1/4	M6	7	12
SSPCF5/32-N01	24.6	5/32	NPT 1/8	8	14
SSPCF5/32-N02	27.6	5/32	NPT 1/4	11	17
SSPCF1/4-N01	24.7	1/4	NPT 1/8	8	14
SSPCF1/4-N02	27.7	1/4	NPT 1/4	11	17
SSPCF5/16-N01	26.3	5/16	NPT 1/8	8	14
SSPCF5/16-N02	29.3	5/16	NPT 1/4	11	17
SSPCF5/16-N03	30.3	5/16	NPT 3/8	12	19
SSPCF5/16-N04	33.3	5/16	NPT 1/2	15	24
SSPCF3/8-N01	28.9	3/8	NPT 1/8	8	17
SSPCF3/8-N02	31.9	3/8	NPT 1/4	11	17
SSPCF3/8-N03	32.9	3/8	NPT 3/8	12	19
SSPCF3/8-N04	35.9	3/8	NPT 1/2	15	24
SSPCF1/2-N02	34.1	1/2	NPT 1/4	11	21
SSPCF1/2-N03	35.1	1/2	NPT 3/8	12	21
SSPCF1/2-N04	38.1	1/2	NPT 1/2	15	24

Stainless Steel Fittings

不锈钢快插接头

SSPCF

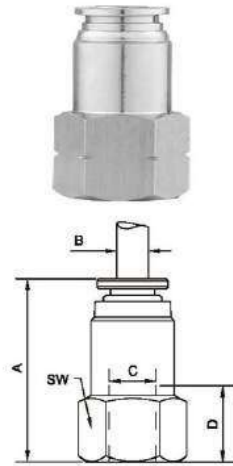

Item Code	A	B	C	D	SW
SSPCF4-G01	24.4	4	G 1/8	8	14
SSPCF4-G02	27.4	4	G 1/4	11	17
SSPCF6-G01	24.7	6	G 1/8	8	14
SSPCF6-G02	27.7	6	G 1/4	11	17
SSPCF8-G01	26.8	8	G 1/8	8	14
SSPCF8-G02	29.8	8	G 1/4	11	17
SSPCF8-G03	30.8	8	G 3/8	12	19
SSPCF8-G04	33.5	8	G 1/2	15	24
SSPCF10-G01	28.9	10	G 1/8	8	17
SSPCF10-G02	31.9	10	G 1/4	11	17
SSPCF10-G03	32.9	10	G 3/8	12	19
SSPCF10-G04	35.9	10	G 1/2	15	24
SSPCF12-G02	34.1	12	G 1/4	11	21
SSPCF12-G03	35.1	12	G 3/8	12	21
SSPCF12-G04	38.1	12	G 1/2	15	24

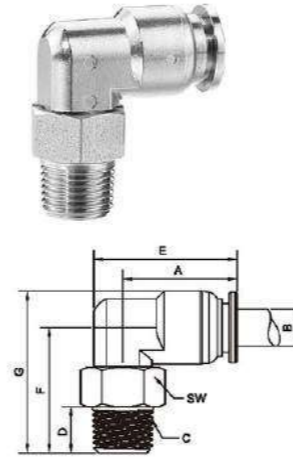

Item Code	A	B	C	D	E	F	G	SW
SSPL5/32-N01	18.6	5/32	NPT 1/8	8	22.1	20	25	12
SSPL5/32-N02	18.6	5/32	NPT 1/4	11	22.1	22.5	27.5	14
SSPL1/4-N01	18.7	1/4	NPT 1/8	8	23.4	21	27	12
SSPL1/4-N02	18.7	1/4	NPT 1/4	11	23.4	20.5	26.5	14
SSPL1/4-N03	18.7	1/5	NPT 3/8	12	23.4	26.5	32.5	19
SSPL1/4-N04	18.7	1/6	NPT 1/2	15	23.4	30.5	36.5	22
SSPL5/16-N01	20	5/16	NPT 1/8	8	25.2	22	29	12
SSPL5/16-N02	20	5/16	NPT 1/4	11	25.2	24.5	31.5	14
SSPL5/16-N03	20	5/16	NPT 3/8	12	25.2	27.5	34.5	19
SSPL5/16-N04	20	5/16	NPT 1/2	15	25.2	31.5	38.5	22
SSPL3/8-N01	24.7	3/8	NPT 1/8	8	31.2	28	36.5	17
SSPL3/8-N02	24.7	3/8	NPT 1/4	11	31.2	31	39.5	17
SSPL3/8-N03	24.7	3/8	NPT 3/8	12	31.2	31	39.5	19
SSPL3/8-N04	24.7	3/8	NPT 1/2	15	31.2	34	42.5	22
SSPL1/2-N02	27.2	1/2	NPT 1/4	11	34.9	32.3	42	17
SSPL1/2-N03	27.2	1/2	NPT 3/8	12	34.9	32.3	42	19
SSPL1/2-N04	27.2	1/2	NPT 1/2	15	34.9	35.3	45	22

SSPL

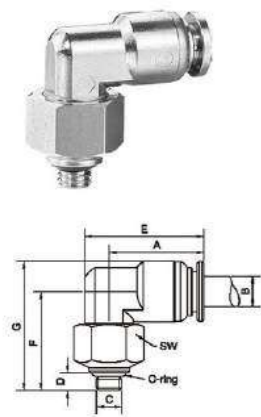

Item Code	A	B	C	D	E	F	G	SW
SSPL4-M5	18.6	4	M5	3.5	22.3	18.5	23.5	12
SSPL4-M6	18.6	4	M6	4.5	22.3	19.5	24.5	12
SSPL6-M5	18.7	6	M5	3.5	23.4	19.5	25.5	12
SSPL6-M6	18.7	6	M6	4.5	23.4	20.5	26.5	12
SSPL5/32-M5	18.6	5/32	M5	3.5	22.3	18.5	23.5	12
SSPL5/32-U10	18.6	5/32	U10-32	3.5	22.3	18.5	23.5	12
SSPL5/32-M6	18.6	5/32	M6	4.5	22.3	19.5	24.5	12
SSPL1/4-M5	18.7	1/4	M5	3.5	23.4	19.5	25.5	12
SSPL1/4-U10	18.7	1/4	U10-32	3.5	23.4	19.5	25.5	12
SSPL1/4-M6	18.7	1/4	M6	4.5	23.4	20.5	26.5	12
SSPL1/4-01U	18.7	1/4	UN1/8	6	23.4	22	28	14

SSPL



Item Code	A	B	C	D	E	F	G	SW
SSPL4-G01	18.6	4	G 1/8	5.5	22.3	20.5	25.5	14
SSPL4-G02	18.6	4	G 1/4	7	22.3	20	25	17
SSPL6-G01	18.7	6	G 1/8	5.5	23.4	21.5	27.5	14
SSPL6-G02	18.7	6	G 1/4	7	23.4	21	27	17
SSPL6-G03	18.7	6	G 3/8	8	23.4	22	28	19
SSPL6-G04	18.7	6	G 1/2	9	23.4	23.5	29.5	24
SSPL8-G01	20	8	G 1/8	5.5	25.2	22.5	29.5	14
SSPL8-G02	20	8	G 1/4	7	25.2	22	29	17
SSPL8-G03	20	8	G 3/8	8	25.2	23	34	19
SSPL8-G04	20	8	G 1/2	9	25.2	24.5	35.5	24
SSPL10-G01	25.2	10	G 1/8	5.5	31.7	26.5	35	17
SSPL10-G02	25.2	10	G 1/4	7	31.7	27.5	36	17
SSPL10-G03	25.2	10	G 3/8	8	31.7	28.5	37	19
SSPL10-G04	25.2	10	G 1/2	9	31.7	29.5	38	24
SSPL12-G02	27.2	12	G 1/4	7	34.9	28.8	38.5	17
SSPL12-G03	27.2	12	G 3/8	8	34.9	26.3	36	19
SSPL12-G04	27.2	12	G 1/2	9	34.9	27.3	37	24

SSPL

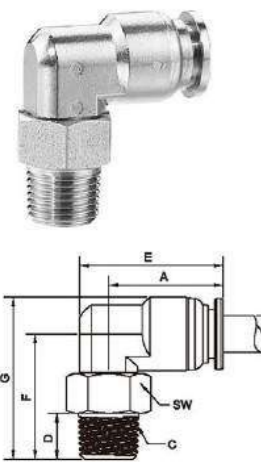

Item Code	A	B	C	D	E	F	G	SW
SSPL4-01	18.6	4	PT 1/8	8	22.3	20	25	12
SSPL4-02	18.6	4	PT 1/4	11	22.3	22.5	27.5	14
SSPL6-01	18.7	6	PT 1/8	8	23.4	21	27	12
SSPL6-02	18.7	6	PT 1/4	11	23.4	23.5	29.5	14
SSPL6-03	18.7	6	PT 3/8	12	23.4	26.5	32.5	19
SSPL6-04	18.7	6	PT 1/2	15	23.4	30.5	36.5	22
SSPL8-01	20	8	PT 1/8	8	25.2	22	29	12
SSPL8-02	20	8	PT 1/4	11	25.2	24.5	31.5	14
SSPL8-03	20	8	PT 3/8	12	25.2	27.5	34.5	19
SSPL8-04	20	8	PT 1/2	15	25.2	31.5	38.5	22
SSPL10-01	25.2	10	PT 1/8	8	31.7	28	36.5	17
SSPL10-02	25.2	10	PT 1/4	11	31.7	31	39.5	17
SSPL10-03	25.2	10	PT 3/8	12	31.7	31	39.5	19
SSPL10-04	25.2	10	PT 1/2	15	31.7	34	42.5	22
SSPL12-02	27.2	12	PT 1/4	11	34.9	32.3	42	17
SSPL12-03	27.2	12	PT 3/8	12	34.9	32.3	42	19
SSPL12-04	27.2	12	PT 1/2	15	34.9	35.3	45	22

SSPT

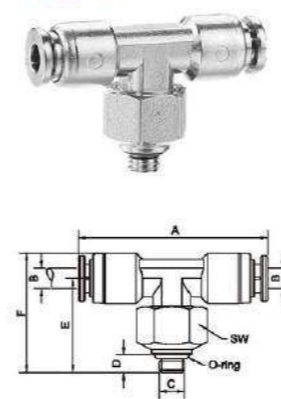

Item Code	A	B	C	D	E	F	SW
SSPT4-M5	37.2	4	M5	3.5	18.5	23.5	12
SSPT4-M6	37.2	4	M6	4.5	19.5	24.5	12
SSPT6-M5	37.4	6	M5	3.5	19.5	25.5	12
SSPT6-M6	37.5	6	M6	4.5	20.5	26.5	12
SSPT5/32-M5	37.2	5/32	M5	3.5	18.5	23.5	12
SSPT5/32-U10	37.2	5/32	U10-32	3.5	18.5	23.5	12
SSPT5/32-M6	37.2	5/32	M6	4.5	19.5	24.5	12
SSPT1/4-M5	37.4	1/4	M5	3.5	19.5	25.5	12
SSPT1/4-U10	37.4	1/4	U10-32	3.5	19.5	25.5	12
SSPT1/4-M6	37.5	1/4	M6	4.5	20.5	26.5	12
SSPT1/4-U01	37.5	1/4	UN1/8	6	22	28	14

Stainless Steel Fittings

不锈钢快插接头

SSPT



Item Code	A	B	C	D	E	F	SW
SSPT4-01	37.2	4	PT 1/8	8	20	25	12
SSPT4-02	37.2	4	PT 1/4	11	22.5	27.5	14
SSPT6-01	37.4	6	PT 1/8	8	21	27	12
SSPT6-02	37.4	6	PT 1/4	11	23.5	29.5	14
SSPT6-03	37.4	6	PT 3/8	12	26.5	32.5	19
SSPT6-04	37.4	6	PT 1/2	15	30.5	36.5	22
SSPT8-01	40	8	PT 1/8	8	22	29	12
SSPT8-02	40	8	PT 1/4	11	24.5	31.5	14
SSPT8-03	40	8	PT 3/8	12	27.5	34.5	19
SSPT8-04	40	8	PT 1/2	15	31.5	38.5	22
SSPT10-01	45.4	10	PT 1/8	8	28	36.5	17
SSPT10-02	45.4	10	PT 1/4	11	31	39.5	17
SSPT10-03	45.4	10	PT 3/8	12	31	39.5	19
SSPT10-04	45.4	10	PT 1/2	15	34	42.5	22
SSPT12-02	54.4	12	PT 1/4	11	32.3	42	17
SSPT12-03	54.4	12	PT 3/8	12	32.3	42	19
SSPT12-04	54.4	12	PT 1/2	15	35.3	45	22

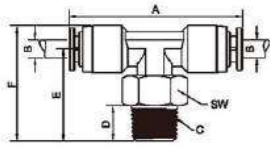

Item Code	A	B	C	D	E	F	SW
SSPT5/32-N01	37.2	5/32	NPT 1/8	8	20	25	12
SSPT5/32-N02	37.2	5/32	NPT 1/4	11	22.5	27.5	14
SSPT1/4-N01	37.4	1/4	NPT 1/8	8	21	27	12
SSPT1/4-N02	37.4	1/4	NPT 1/4	11	20.5	26.5	14
SSPT1/4-N03	37.4	1/4	NPT 3/8	12	26.5	32.5	19
SSPT1/4-N04	37.4	1/4	NPT 1/2	15	30.5	36.5	22
SSPT5/16-N01	40	5/16	NPT 1/8	8	22	29	12
SSPT5/16-N02	40	5/16	NPT 1/4	11	24.5	31.5	14
SSPT5/16-N03	40	5/16	NPT 3/8	12	27.5	34.5	19
SSPT5/16-N04	40	5/16	NPT 1/2	15	31.5	38.5	22
SSPT3/8-N01	45.4	3/8	NPT 1/8	8	28	36.5	17
SSPT3/8-N02	45.4	3/8	NPT 1/4	11	31	39.5	17
SSPT3/8-N03	45.4	3/8	NPT 3/8	12	31	39.5	19
SSPT3/8-N04	45.4	3/8	NPT 1/2	15	34	42.5	22
SSPT1/2-N02	54.4	1/2	NPT 1/4	11	32.3	42	17
SSPT1/2-N03	54.4	1/2	NPT 3/8	12	32.3	42	19
SSPT1/2-N04	54.4	1/2	NPT 1/2	15	35.3	45	22

SSPT

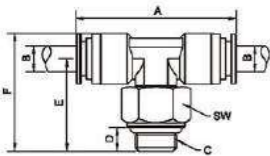

Item Code	A	B	C	D	E	F	SW
SSPT4-G01	37.2	4	G 1/8	8	20.5	25.5	14
SSPT4-G02	37.2	4	G 1/4	11	20	25	17
SSPT6-G01	37.4	6	G 1/8	8	21.5	27.5	14
SSPT6-G02	37.4	6	G 1/4	11	21	27	17
SSPT6-G03	37.4	6	G 3/8	12	22	28	19
SSPT6-G04	37.4	6	G 1/2	15	23.5	29.5	24
SSPT8-G01	40	8	G 1/8	8	22.5	29.5	14
SSPT8-G02	40	8	G 1/4	11	22	29	17
SSPT8-G03	40	8	G 3/8	12	23	34	19
SSPT8-G04	40	8	G 1/2	15	24.5	35.5	24
SSPT10-G01	45.4	10	G 1/8	31.7	26.5	35	17
SSPT10-G02	45.4	10	G 1/4	31.7	27.5	36	17
SSPT10-G03	45.4	10	G 3/8	31.7	28.5	27	19
SSPT10-G04	45.4	10	G 1/2	31.7	29.5	28	24
SSPT12-G02	54.4	12	G 1/4	34.9	28.8	38.5	17
SSPT12-G03	54.4	12	G 3/8	34.9	26.3	36	19
SSPT12-G04	54.4	12	G 1/2	34.9	27.3	37	24

SSPUC



Item Code	A	B	C
SSPUC4	32.4	10.5	4
SSPUC6	32.6	12.5	6
SSPUC8	35.6	14.5	8
SSPUC10	41.1	17.5	10
SSPUC12	44.7	19.5	12

Item Code	A	B	C
SSPUC5/32	32.4	10.5	5/32
SSPUC1/4	32.6	12.5	1/4
SSPUC5/16	35.6	14.5	5/16
SSPUC3/8	41.1	17.5	3/8
SSPUC1/2	44.7	19.5	1/2

SSPUL

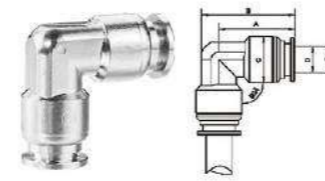

Item Code	A	B	C	D
SSPUL4	18.6	22.3	10	4
SSPUL6	18.7	23.4	12	6
SSPUL8	20	25.2	14	8
SSPUL10	24.7	31.2	17	10
SSPUL12	27.2	34.9	19.5	12

Item Code	A	B	C	D
SSPUL5/32	18.6	22.3	10	5/32
SSPUL1/4	18.7	23.4	12	1/4
SSPUL5/16	20	25.2	14	5/16
SSPUL3/8	24.7	31.2	17	3/8
SSPUL1/2	27.2	34.9	19.5	1/2

SSPUT

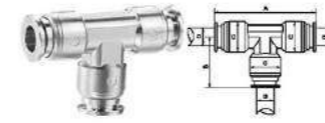

Item Code	A	B	C	D
SSPUT4	37.2	18.6	10	4
SSPUT6	18.7	23.4	12	6
SSPUT8	20	25.2	14	8
SSPUT10	24.7	31.2	17	10
SSPUT12	27.2	34.9	19.5	12

Item Code	A	B	C	D
SSPUT5/32	18.6	22.3	10	5/32
SSPUT1/4	18.7	23.4	12	1/4
SSPUT5/16	20	25.2	14	5/16
SSPUT3/8	24.7	31.2	17	3/8
SSPUT1/2	27.2	34.9	19.5	1/2

SSPMM

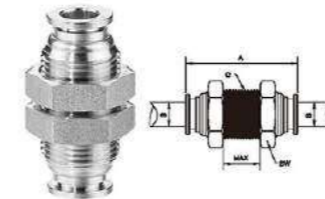

Item Code	A	B	C	SW	MAX
SSPMM4	32.4	4	M12*1	14	9.5
SSPMM6	32.6	6	M14*1	17	9.5
SSPMM8	35.6	8	M16*1	19	12
SSPMM10	41.1	10	M20*1	24	14
SSPMM12	44.7	12	M22*1	26	17

Item Code	A	B	C	SW	MAX
SSPMM5/32	32.4	5/32	M12*1	14	9.5
SSPMM1/4	32.6	1/4	M14*1	17	9.5
SSPMM5/16	35.6	5/16	M16*1	19	12
SSPMM3/8	41.1	3/8	M20*1	24	14
SSPMM1/2	44.7	1/2	M22*1	26	17

SSPG



Item Code	A	B	C	D	E
SSPG12-10	42.9	10	12	17.5	19.5
SSPG10-8	38.4	8	10	14.5	17.5
SSPG8-6	34.1	6	8	12.5	14.5
SSPG6-4	28.8	4	6	12.5	10.5

Item Code	A	B	C	D	E
SSPG1/2-3/8	42.9	3/8	1/2	17.5	19.5
SSPG3/8-5/16	38.4	5/16	3/8	14.5	17.5
SSPG5/16-1/4	34.1	1/4	5/16	12.5	14.5
SSPG1/4-5/32	28.8	5/32	1/4	12.5	10.5